



Operating Manual

13 June 2019

Version: 1.1

C.I.E. **CHAMPION
INDUSTRIAL
EQUIPMENT**

2855 Marleau Avenue, Suite A, Cornwall, Ontario K6H 7B6

Tel: 613 938-2900 Fax: 613 938-8219

www.cie-eic.com

All rights reserved.

This document is owned by CIE property. No part of this publication may be reproduced, distributed, or transmitted in any form or by any means, including photocopying, recording, or other electronic or mechanical methods, without the prior written permission of the publisher, except in the case of brief quotations embodied in critical reviews and certain other non-commercial uses permitted by copyright law.



2855 Marleau Avenue, Suite A, Cornwall, Ontario K6H 7B6
Tel: 613 938-2900 Fax: 613 938-8219
www.cie-eic.com

Table of contents

1	GETTING STARTED	4
1.1	PACKAGING INFORMATION.....	4
1.2	CONNECTING TO THE POWER SUPPLY, AND TURNING ON	4
1.3	INSTRUMENT OVERVIEW.....	4
1.4	PRINTER PAPER TYPE AND CHANGE	5
1.5	SAMPLE PRESENTATION	5
1.5.1	<i>Filling the sample in</i>	<i>5</i>
1.5.2	<i>Removing the sample.....</i>	<i>6</i>
2	SOFTWARE MENU ITEMS.....	6
2.1	MAIN MENU & GENERAL FUNCTIONS.....	6
2.1.1	<i>User roles.....</i>	<i>6</i>
2.1.2	<i>Status bar</i>	<i>7</i>
2.1.3	<i>Help.....</i>	<i>8</i>
2.1.4	<i>Using the keyboard.....</i>	<i>9</i>
2.2	ANALYSIS.....	9
2.3	RESULTS.....	11
2.4	SETTINGS	13
2.4.1	<i>User specific settings</i>	<i>13</i>
2.4.2	<i>Device related settings.....</i>	<i>14</i>
2.5	CALIBRATIONS.....	14
2.6	DIAGNOSTICS.....	15
3	POP-UP WINDOWS	16
3.1	DEFINED MESSAGES.....	16
3.2	UNEXPECTED ERRORS.....	18



2855 Marleau Avenue, Suite A, Cornwall, Ontario K6H 7B6
Tel: 613 938-2900 Fax: 613 938-8219
www.cie-eic.com

1 Getting started

1.1 Packaging information

IMPORTANT NOTICE:

Please keep the original packaging of the instrument! The instrument can be delivered only in the original packaging! CIE does not take responsibility for any damages occurring due to improper packaging and delivery.

1.2 Connecting to the power supply, and turning on

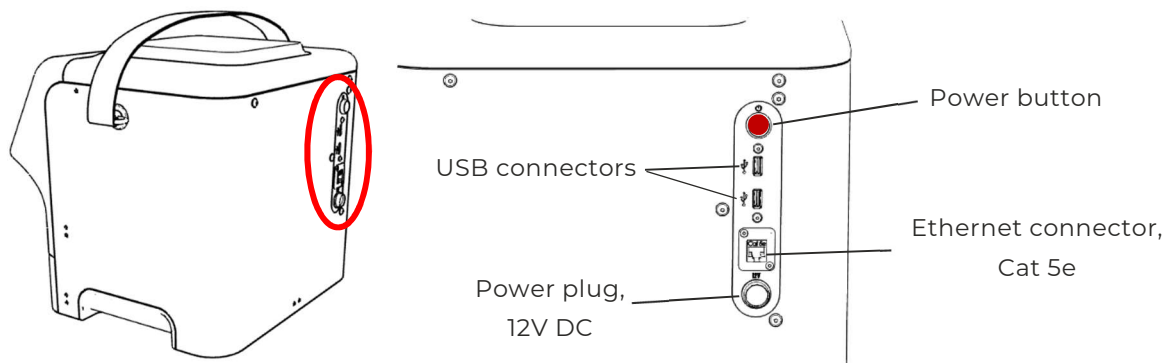

Connect the instrument to the electric network (100~240VAC, 50/60Hz) and switch it on with the red button found on the back of the instrument.

Connect to internet (Ethernet cable or Wi-Fi) to access automatic Cloud synchronization. This keeps your measurement results safe and remotely accessible, and ensures that you always have the latest, most up-to-date calibrations and device parameters.

In normal ambient conditions the instrument does not need any time for warming up so you can start measuring right after switching it on.

1.3 Instrument overview



1.4 Printer paper type and change

The printer works with 57 mm wide paper used for thermal printers. The diameter of the reel cannot be more than 50 mm.

For changing of the paper push the green lighting button on the left side of the printer. While keeping it pushed pull one of the plastic cover fixing levers upwards. Open the cover, empty the paper housing and put the new paper reel into it with the running end of the paper upwards. (See the next figure.) Close the cover. Please make sure that the two fixing levers snap into their places. The printer is ready for use, again.

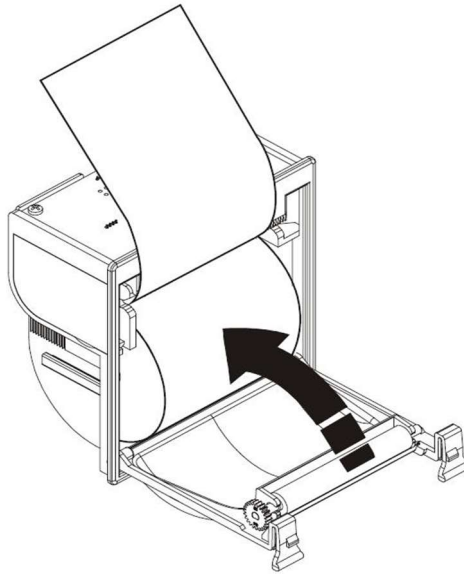

1.5 Sample presentation

Sample handling does not need any special tool or skill. For whole grain analysis no sample preparation is needed.

1.5.1 Filling the sample in

In simpler terms: it just has to fill the chamber – you should not be able to see the black chamber walls, only the white hopper slopes. For analysis the necessary amount of the sample varies with the type of *Product* in question, but 400 ml volume is sufficient for all compatible kind.

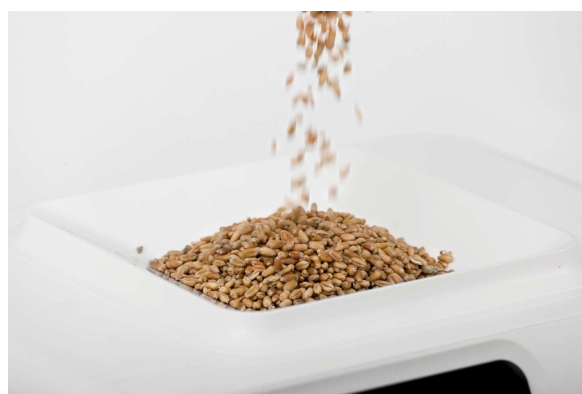

1.5.2 Removing the sample

At the end of the measurement process releases the sample automatically into the sample drawer:



2 Software menu items

2.1 Main menu & general functions

The next figure shows the main menu:



The required function group can be accessed by pressing the menu buttons.

2.1.1 User roles

The access to the functions of the instrument is driven by the actual role of the user. The users can have different roles:

- Normal user: access to all functions needed for everyday use. No access to any service functions or functional parameters.
- Experienced user: access to basic adjustments (e.g. bias and slope adjustments of calibrations), but no access to most device settings and service functions.
- Service user: access to all settings and service functions, but no access to factory parameters.
- Factory user: full access.

The functions the actual user role does not have access to are inactive for that user.

To log in as an advanced user (all other than normal) a password is needed. The service user password is only available for service partners, the factory user role can only be used for CIE service engineers.

Default user role is 'Normal user'. To change the role, press the menu  button on the right side of the top bar. After that press "Change user":

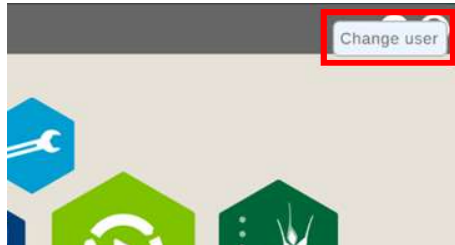

Select the user role and enter the password.

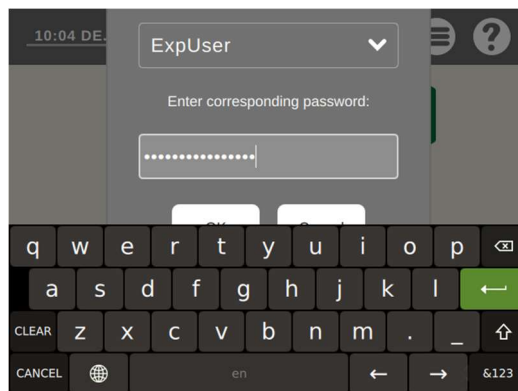

IMPORTANT WARNING:

When logging in as Experienced user, please make sure that you are fully aware of the operation (and functions) of the services and parameters! Incorrect adjustment of the values may cause invalid measurement results or even make the instrument unable to perform analyses!

2.1.2 Status bar

All function screens are headed by a status bar to display additional information and access further functions related to the main function group.

The different function groups are marked with different colours: the colour of the status bar and the colouring of the screen makes easy to identify where we are in the software at any moment.

The status bar contains the following information:

Main menu:



Function groups:

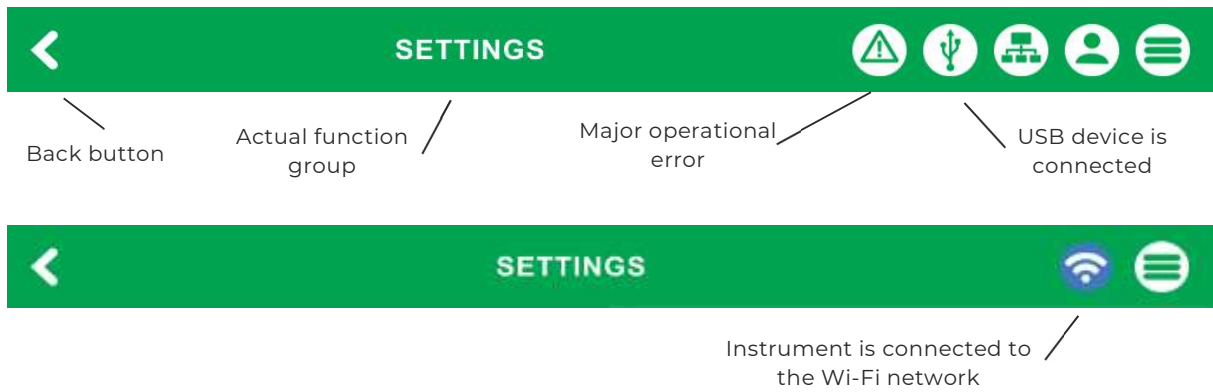

In an everyday use, for a normal user there are only 2 icons displayed on the status bar, if the instrument is not connected to the internet and no USB-device is connected:



To safely remove a connected USB-device, find the USB-icon on the status bar in any view:



Press long on the USB-icon. Once it is safe to remove, a pop-up message appears in the screen centre saying 'Safe to remove pendrive':



2.1.3 Help

Provides context sensitive help for the actual function. To access Help content, press the question mark  on the top bar of each function.

2.1.4 Using the keyboard

By clicking on any editable text field, the keyboard will be displayed at the bottom of the screen:



2.2 Analysis

Analysis functions can be accessed by pressing the 'Analysis' icon on the main screen:

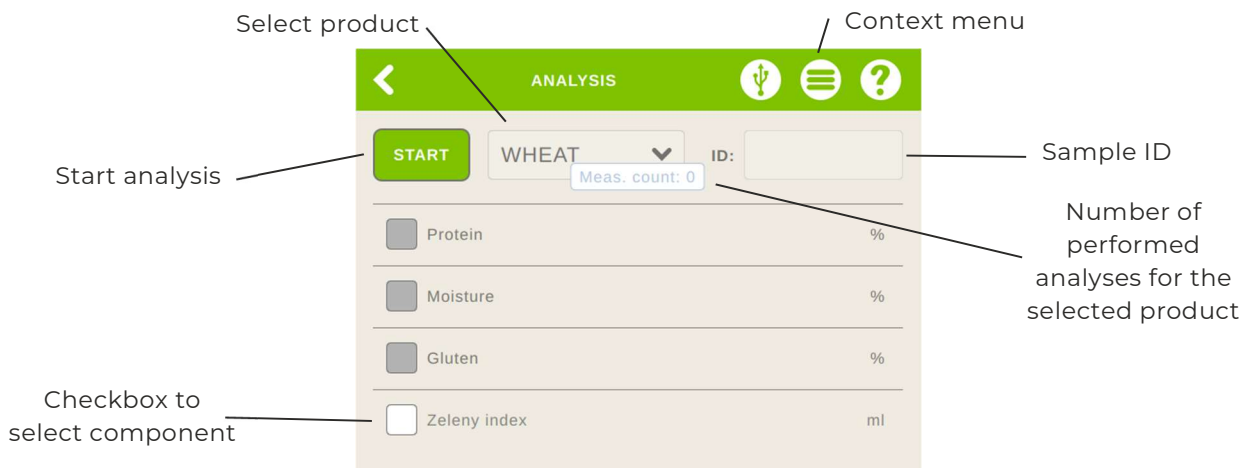

Components can be turned off by unchecking the checkbox:

(The components can be turned off permanently in Calibrations menu)

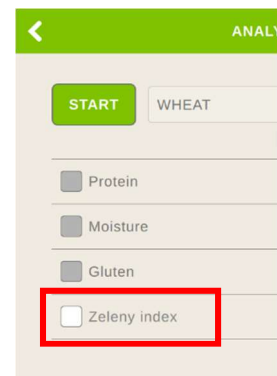

During the analysis the actual transmission values are displayed on the screen:

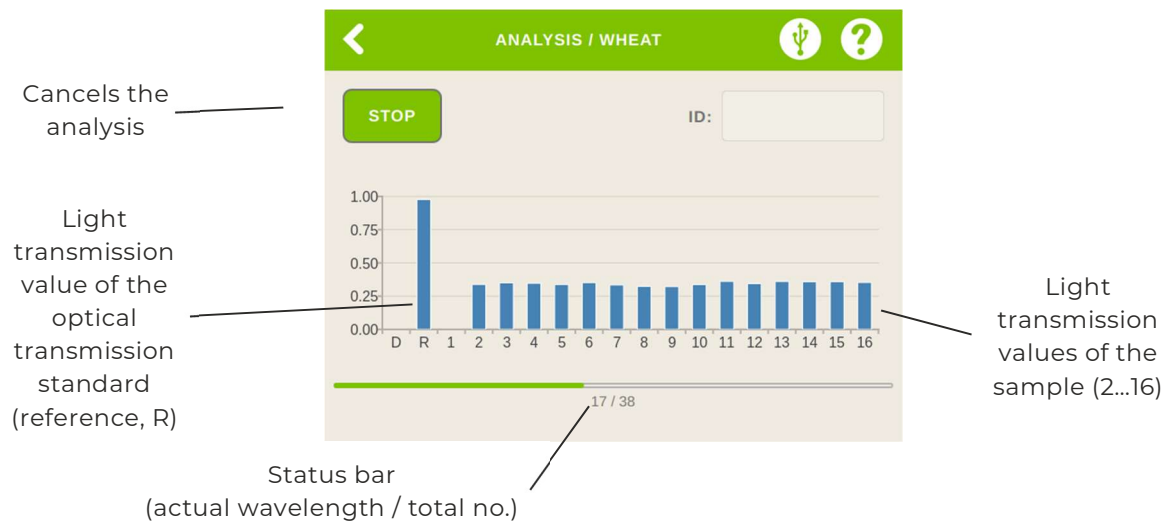

At the end of the measurement the results are displayed on the screen:

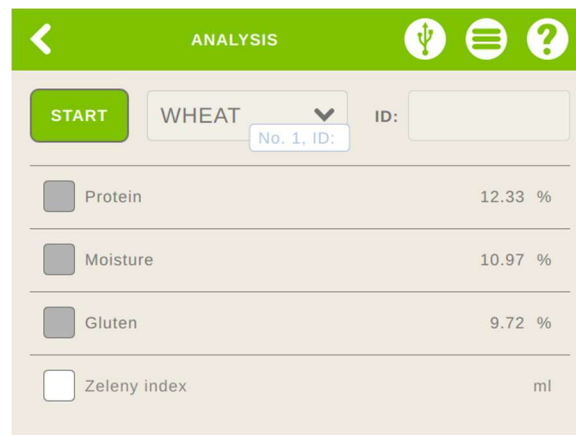

When pressing context menu

- *Empty all content*: opens the bottom door of the measurement chamber and releases the sample to the drawer,
- *Clean chamber*: opens bottom door of the measurement chamber and sets chamber to maximum width to help you clean it better.

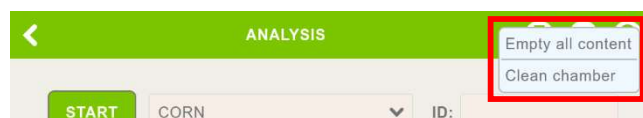

2.3 Results

Results of the selected product can be accessed by pressing the 'Results' icon on the main screen:



The results of the selected product are shown in a table view:

Graph view Context menu

Statistics section

Header

Sorting arrow

List of results

No.	Protein [%]	Moisture [%]	Gluten [%]	Shelby index [m]	...
10	13.12	10.66	30.54	58.21	
11	13.37	10.29	34.32	67.87	
12	13.13	10.75	28.07	51.92	
13	11.67	10.11	29.89	56.56	
14	11.93	10.13	29.61	55.84	

Possible actions on the results screen:

- Change the order columns: press and hold the header of the column and move the column to the left or right to the desired position:

No.	Protein [%]	Moisture [%]	Gluten [%]
105	10.49	12.74	21.95
104	10.31	12.73	21.87
102	13.87	11.88	30.47
101	13.47	11.84	29.52

- Sort the records by different results: press the header of the column containing the data you want to sort the records by. By pressing the arrow, you can sort the records ascending or descending:

Moisture [%]
12.74
12.73
11.88
11.84
11.81
10.10

- Operations with records if you press long on them (multiple selection possible): *Print selected*, or *Delete selected*

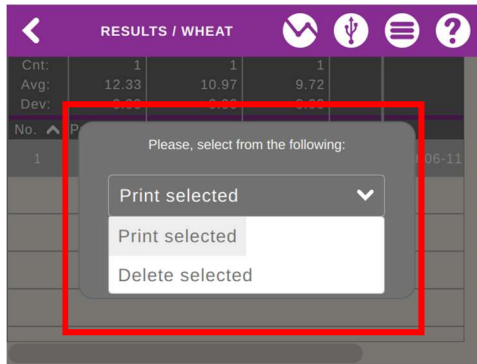

- Functions in the context menu:

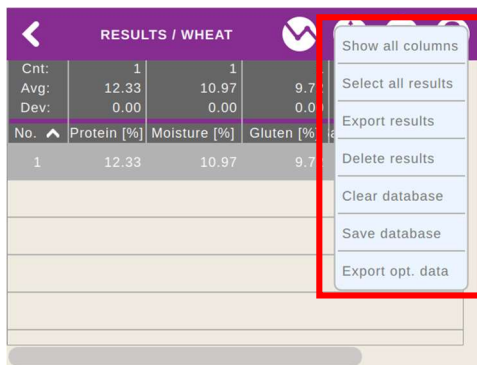

- o *Show all columns*: resizes the columns to fit into the display.
- o *Export results*: exports results to xls/txt file and save to USB pen drive.
- o *Delete results*: deletes all (or selected) results from this product.
- o *Clear database*: clears all result from all products from the database.
- o *Save database*: saves complete database to USB pen drive.
- o *Export opt. data*: exports optical raw data to USB pen drive

- Data visualization in the Graph view: pressing the 'graph' icon on the status bar will lead to the graphical view of the data:

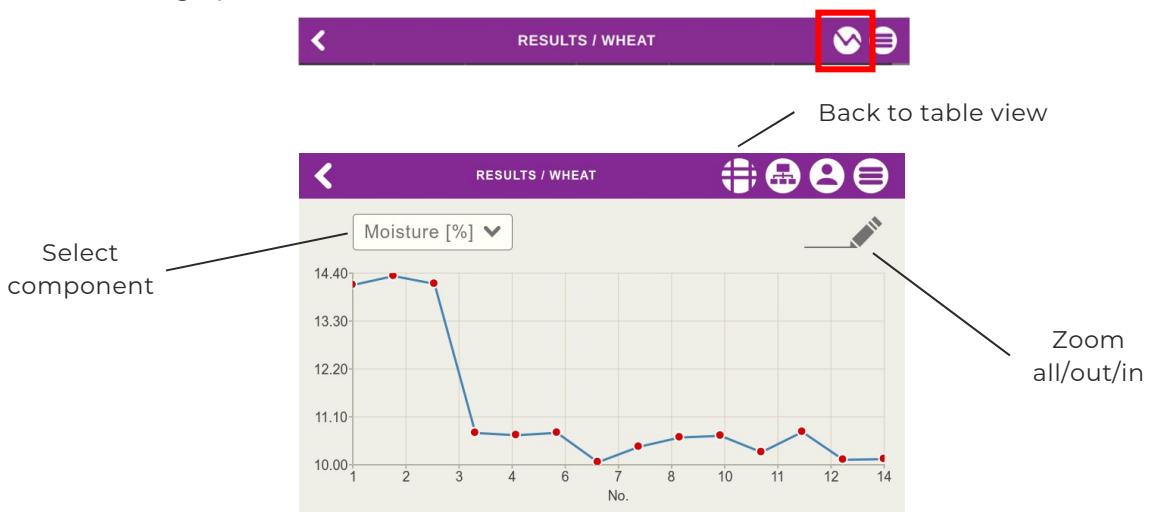

2.4 Settings

Instrument parameters are accessible by pressing the 'Settings' icon of the main menu.



Parameters are placed on 2 tabs: user specific settings and device related setting. User specific settings are related to the preferences and use cases of the person operating the instrument, device related settings are related to the instrument itself and are independent from the person who actually uses the instrument.

Most settings are accessible only for advanced users: these can only be modified if an experienced user is logged in.

2.4.1 User specific settings

User related setting are the parameters of the operating *Environment* (language, date & time, owner, etc.), the *Device*, the *Analysis* and the *Network* (Server IP, Ethernet and Wireless IP addresses, etc.).

Some are possible to modify by users, if needed:

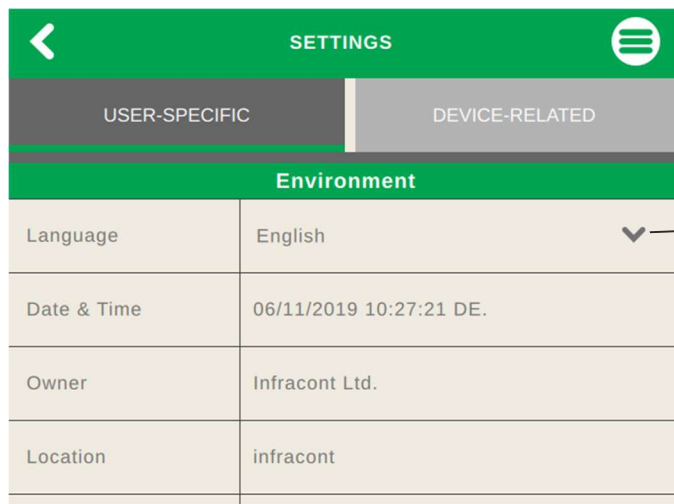

Select language

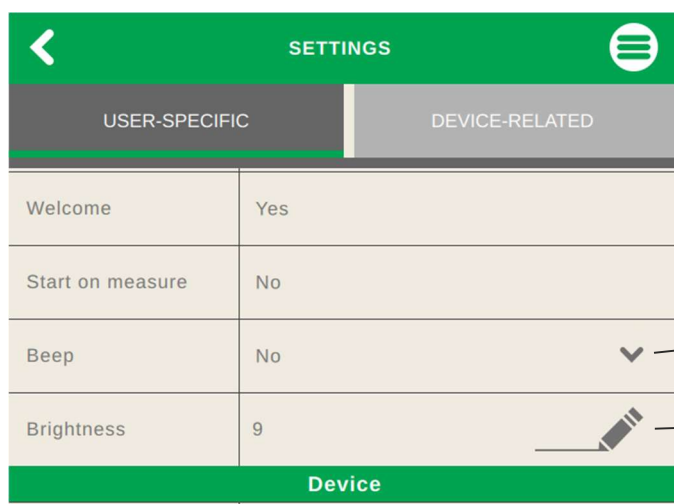

Turn on/off beeping for touch-screen operations

Screen brightness adjustment between 1 (dark) and 10 (bright).

SETTINGS	
USER-SPECIFIC	DEVICE-RELATED
Device	
Self-test interval [h]	8
Analysis	
Nr. of printed receipt	1
Network	
Server IP:P	

Self-test interval in hours: the instrument runs the self-diagnostic process once in every set hours (after turning on).

Set *Nr. of printed receipts* in pieces per measurement.

2.4.2 Device related settings

In this tab you can check

- the instrument's serial number (S/N),
- the current software's version number,
- the *checksum* and the *last modification* date of latest calibration,
- whether the instrument is *Certified* for official grain trade.

SETTINGS		SETTINGS	
USER-SPECIFIC	DEVICE-RELATED	USER-SPECIFIC	DEVICE-RELATED
Device		Versions & Updates	
Manufacturer	Infracont Ltd.	SW version	3.11.04.test.debug
Type	SGrain	Calibr. checksum	60ca5cb23d189c13cb903a7ea86af76 2047fa82e6b2fa4370d494d10c49411 51
S/N.	7-19-0000-01	Calibr. last mod	06/11/2019 9:41:51 DE.
Versions & Updates		Legalization	
SW version	3.11.04.test.debug	Certified	No

2.5 Calibrations

Available calibrations are accessible by pressing the 'Calibrations' icon on the main screen.



Select a product to access properties and available components:

CALIBRATIONS		CALIBRATIONS / CORN	
		PROPERTIES	COMPONENTS (5)
CORN	>	Name	CORN
DURUM	>	Remark	-SPE_CORN10
OATS	>	Status	Active
RAPESEED	>	Cuvette	Grain
RYE	>	Thickness [mm]	30
SOYBEAN	>		

On the *Properties* tab the general properties of the calibrations of the selected product are displayed:

- *Name* of the product,
- *Status* of the product; reads *Active* if it's currently chosen for analysis,
- *Cuvette* specification if needed; reads *Grain* if *Cuvette* is not needed,
- *Thickness*: optical path length of measurement chamber.

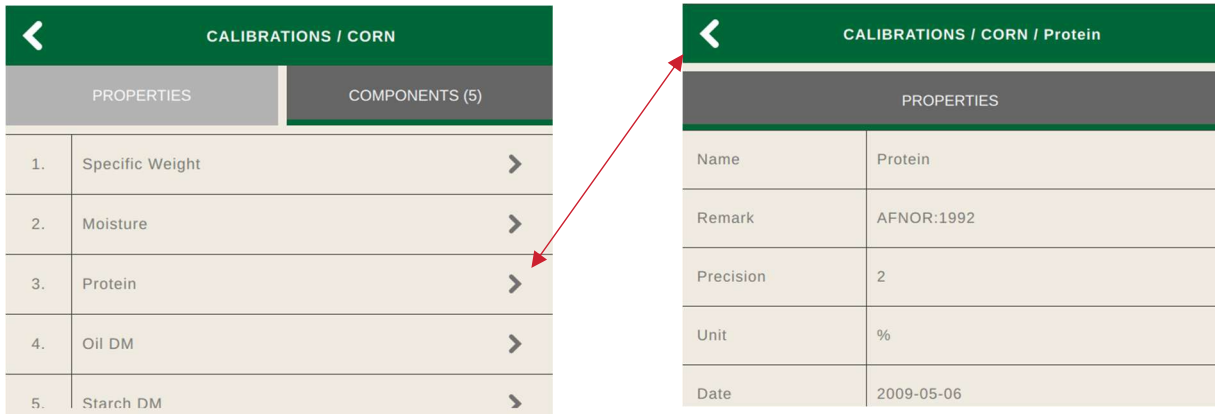

The Components tab lists the quality parameters that can be measured in the selected product.

The *Properties* of a component contain substantial information about the calibration for the selected component, such as:

- *Precision*: number of decimals displayed for the results,
- *Unit*: measurement unit of component e.g. percent [%], specific weight [kg/hl], volume [ml], etc.
- *Date*: date of component calibration,
- *Certified*: reads *Yes* if the component (e.g. moisture) is certified for official grain trade.

2.6 Diagnostics

You can run a self-test any time by pressing the 'Diagnostics' icon on the main screen:



The self-test checks the most important hardware and electronic components of the instrument.

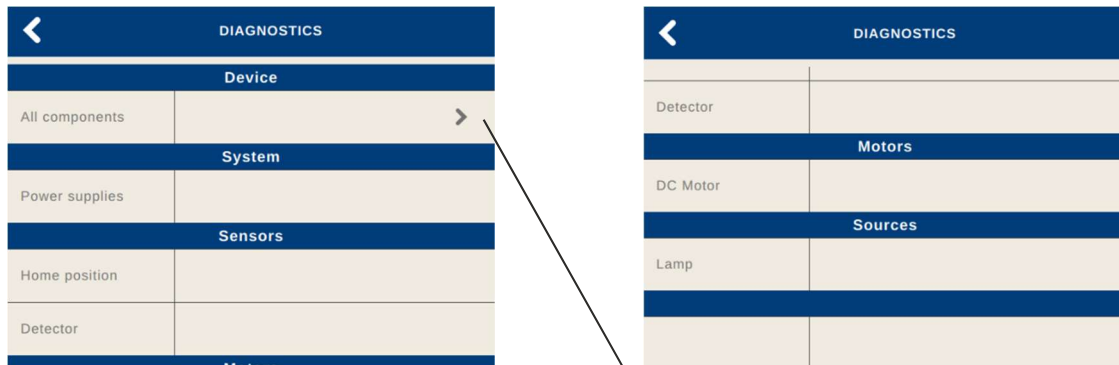

Start self-diagnostic. Before starting the process, please empty all content from the chamber!

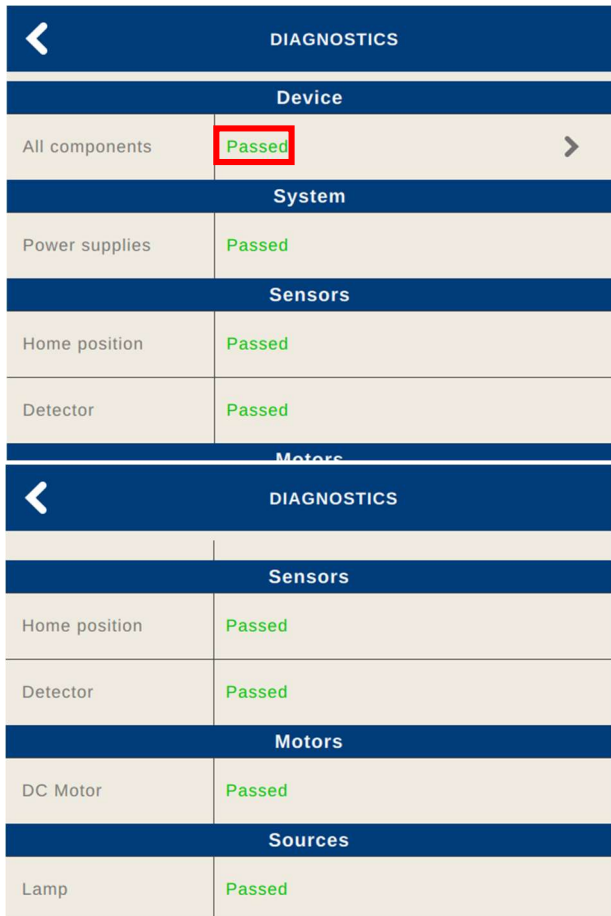

If the instrument works properly, you should see that all functional components ***Passed***.

If any of the components reads ***Failed***, please contact the local distributor.

If any of the components reads ***Passed with caution***, a necessary recalibration and/or service date might be closing up, but the instrument is still operating reliable. Contact the local distributor to schedule a service operation.

3 Pop-up windows

3.1 Defined messages

Table of messages appearing on-screen and requiring user interaction. Each message has a color-coded frame:

- *Green* frames provide status info or ask for self-explanatory action during the everyday operation e.g. pushing the drawer into the fix position:

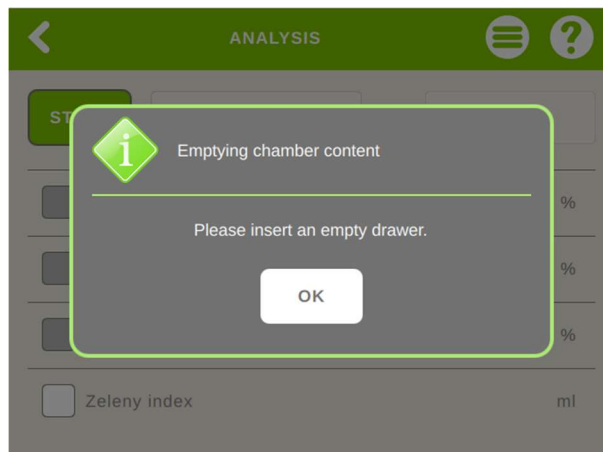

- *Yellow* frames ask for a user action not necessarily occurring during everyday operation:

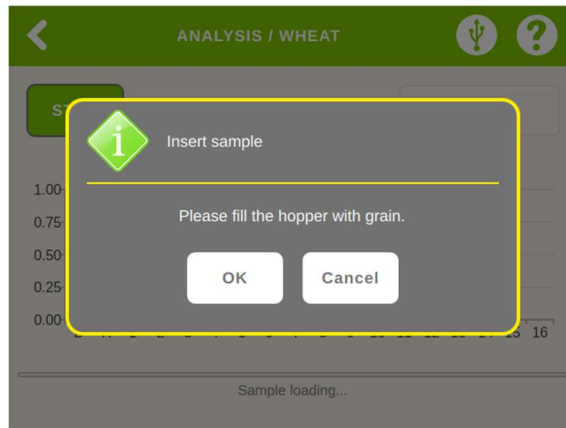

- Red framed error messages signal that some operation could not finish, and user or service action may be required:

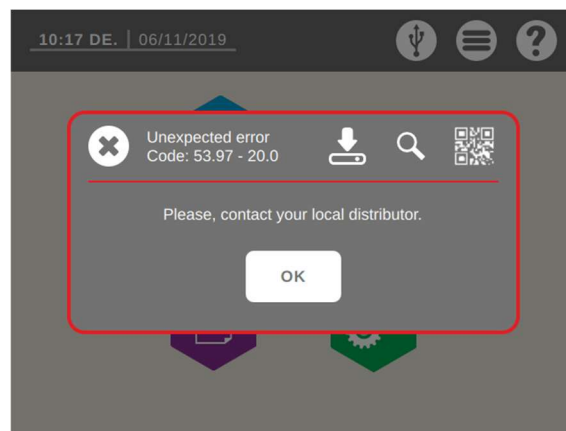

- Grayframes pop-up when you try to edit a setting. They ask for parameter values, i.e. passwords, or offer drop-down menus. User action: choose or type in a parameter value using the touchscreen. See section 2.1.1 for an example with selection of user role.

Header / Error code / Message	Color	Screen	User Action
Invalid analysis / E 05 / Insufficient number of submeasurements because of signal underflow.	Red	Analysis	1. Make sure correct <i>Product</i> is selected. 2. Clean the chamber, see section 2.2. 3. If the error persists contact your local distributor.
Invalid analysis / E 04 / Insufficient number of submeasurements because of signal overflow.	Red	Analysis	1. Make sure correct <i>Product</i> is selected. 2. If the error persists contact your local distributor.
Invalid analysis / E 07 / Insufficient number of submeasurements after component range check in ... (... instead of ...). Below the limit: ..., above the limit: ...	Red	Analysis	1. Make sure correct <i>Product</i> is selected. 2. Clean the chamber, see section 2.2. 3. If the error persists contact your local distributor.
Few sample for bulk density measurement / x / Please insert more grain into the hopper.	Yellow	Analysis	1. Load more sample to the chamber and press <i>OK</i> . 2. If the error persists, check if there is any grain left in the chamber. Remove the drawer and try moving the fork-like bottom opener. 3. If it is stuck or the error persists contact your local distributor.
Chamber cleaning / x / Please clean the chamber and click <i>OK</i> .	Yellow	Analysis	WARNING! Use of original instrument accessories is advised. Sharp, hard tools of metal or containing microparticles harm the optical path and deteriorate the performance of the instrument!
Large measurement deviation / x / Please refill and repeat the measurement.	Yellow	Analysis	1. Make sure correct <i>Product</i> is selected. 2. Refill, and repeat the measurement. 3. If the error persists clean the chamber, see section 2.2. 4. If the error persists contact your local distributor.

3.2 Unexpected errors

If a not specified error message appears on-screen, please send the error log text to your local distributor following the next steps.

1. Press the QR-code icon in the top right corner:

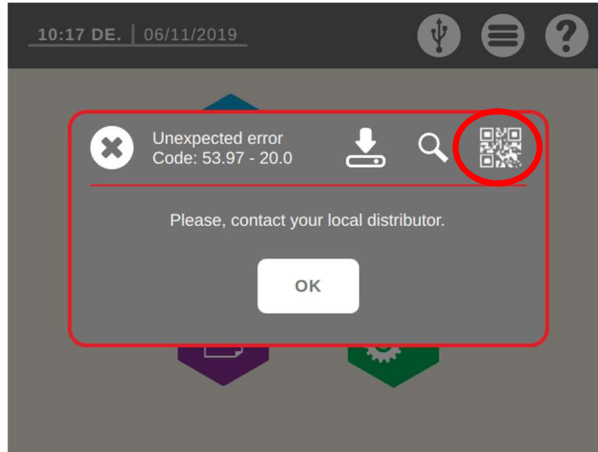

2. Read out the enlarged QR-code with your smartphone:



3. Send the error log text to your local distributor:

